

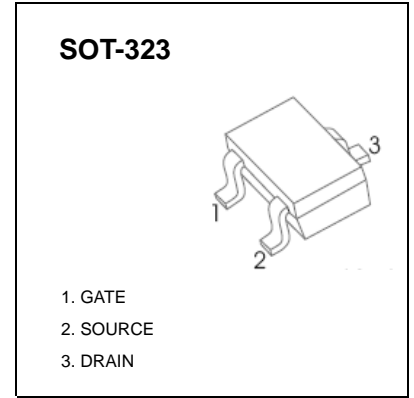

**SOT-323 Plastic-Encapsulate MOSFETS**

**CJ2102** N-Channel MOSFET

$V_{(BR)DSS}$	$R_{DS(on)MAX}$	$I_D$
20V	68mΩ@4.5V	2.1A
	115mΩ@2.5V	



**FEATURE**

- TrenchFET Power MOSFET

**APPLICATION**

- Load Switch for Portable Devices
- DC/DC Converter

**MARKING**

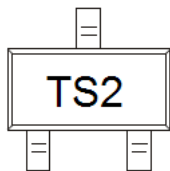

**Equivalent Circuit**

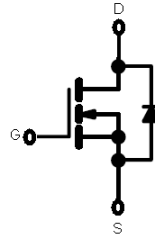

**Maximum ratings ( $T_a=25^{\circ}C$  unless otherwise noted)**

Parameter	Symbol	Value	Unit
Drain-Source Voltage	$V_{DS}$	20	V
Gate-Source Voltage	$V_{GS}$	±8	
Continuous Drain Current	$I_D$	2.1	A
Continuous Source-Drain Current(Diode Conduction)	$I_S$	0.6	
Power Dissipation	$P_D$	0.2	W
Thermal Resistance from Junction to Ambient ( $t \leq 5s$ )	$R_{\theta JA}$	625	$^{\circ}C/W$
Operation Junction and Storage Temperature Range	$T_J, T_{STG}$	-55 ~ +150	$^{\circ}C$

## MOSFET ELECTRICAL CHARACTERISTICS

$T_a=25^\circ\text{C}$  unless otherwise specified

Parameter	Symbol	Test Condition	Min	Typ	Max	Unit
<b>Static Characteristics</b>						
Drain-source breakdown voltage	$V_{(BR)DSS}$	$V_{GS} = 0V, I_D = 10\mu A$	20			V
Gate-threshold voltage	$V_{GS(th)}$	$V_{DS} = V_{GS}, I_D = 50\mu A$	0.65	0.95	1.2	
Gate-body leakage	$I_{GSS}$	$V_{DS} = 0V, V_{GS} = \pm 8V$			$\pm 100$	nA
Zero gate voltage drain current	$I_{DSS}$	$V_{DS} = 20V, V_{GS} = 0V$			1	$\mu A$
Drain-source on-resistance <sup>1</sup>	$R_{DS(on)}$	$V_{GS} = 4.5V, I_D = 3.6A$		0.059	0.068	$\Omega$
		$V_{GS} = 2.5V, I_D = 3.1A$		0.070	0.115	
Forward transconductance <sup>1</sup>	$g_{fs}$	$V_{DS} = 5V, I_D = 3.6A$		8		S
Diode forward voltage	$V_{SD}$	$I_S = 0.94A, V_{GS} = 0V$		0.76	1.2	V
<b>Dynamic Characteristics</b>						
Total gate charge	$Q_g$	$V_{DS} = 10V, V_{GS} = 4.5V, I_D = 3.6A$		4.0	10	nC
Gate-source charge	$Q_{gs}$			0.65		
Gate-drain charge	$Q_{gd}$			1.5		
Input capacitance <sup>2</sup>	$C_{iss}$	$V_{DS} = 10V, V_{GS} = 0V, f = 1MHz$		300		pF
Output capacitance <sup>2</sup>	$C_{oss}$			120		
Reverse transfer capacitance <sup>2</sup>	$C_{rss}$			80		
<b>Switching Characteristics<sup>2</sup></b>						
Turn-on delay time	$t_{d(on)}$	$V_{DD} = 10V,$ $R_L = 5.5\Omega, I_D \approx 3.6A,$ $V_{GEN} = 4.5V, R_g = 6\Omega$		7	15	ns
Rise time	$t_r$			55	80	
Turn-off delay time	$t_{d(off)}$			16	60	
Fall time	$t_f$			10	25	

**Notes :**

1. Pulse Test : Pulse width  $\leq 300\mu s$ , duty cycle  $\leq 2\%$ .
2. These parameters have no way to verify.

# Typical Characteristics

Output Characteristics

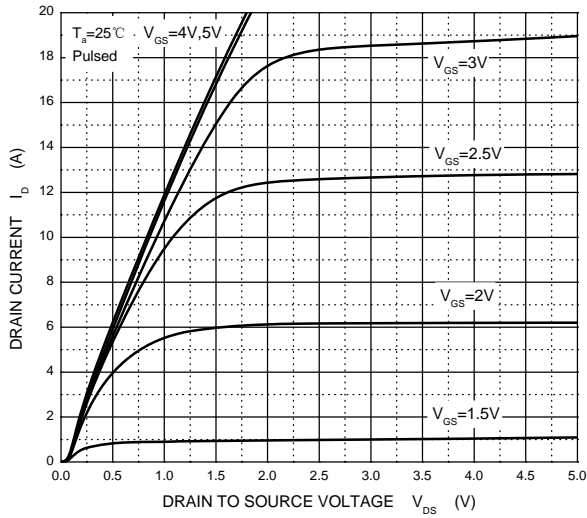

Transfer Characteristics

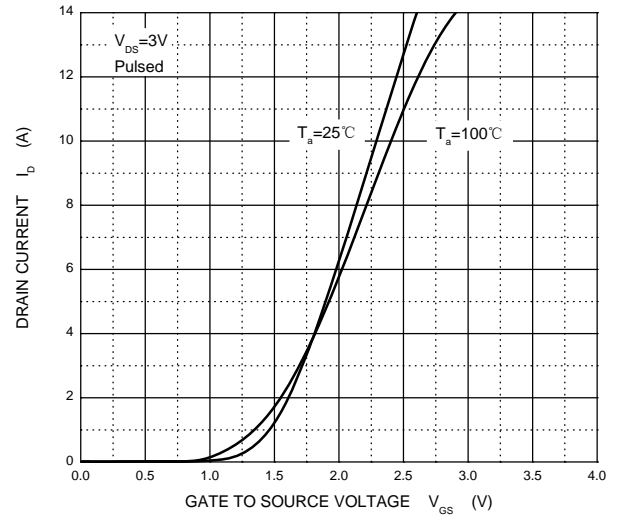

$R_{DS(ON)}$  —  $I_D$

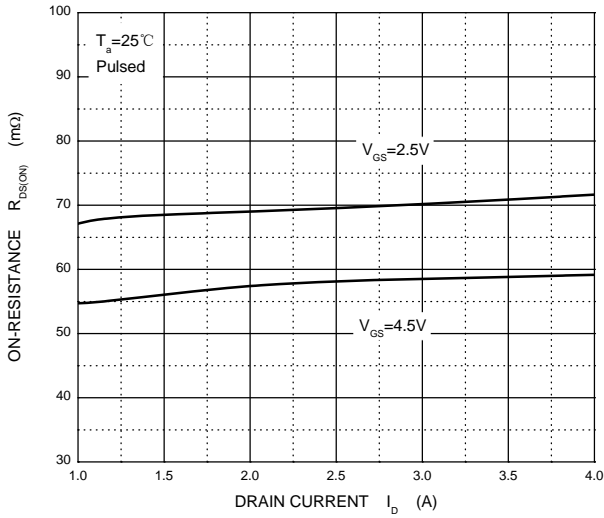

$R_{DS(ON)}$  —  $V_{GS}$

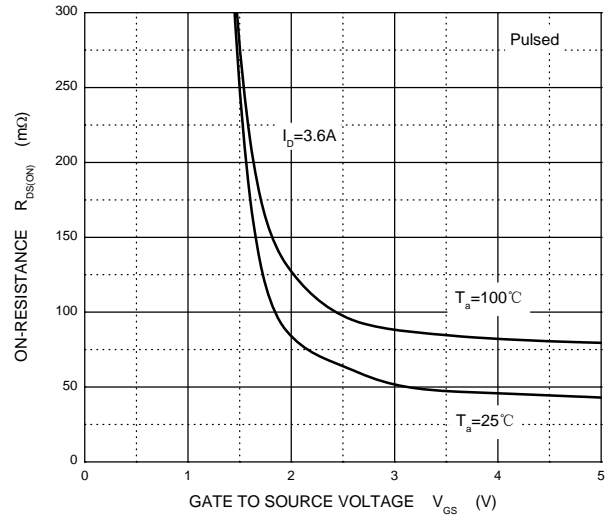

$I_S$  —  $V_{SD}$

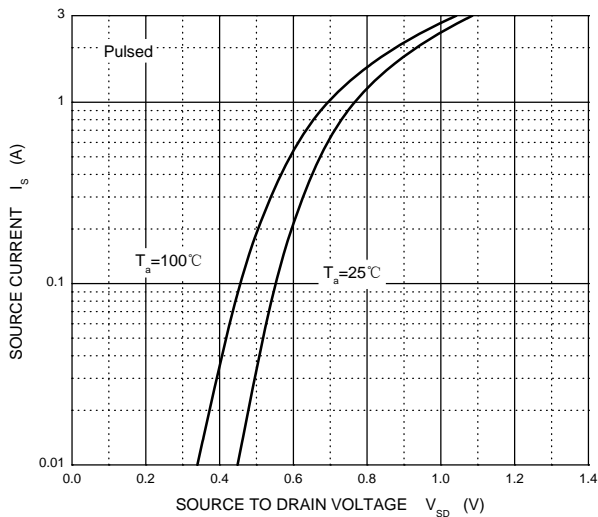

Threshold Voltage

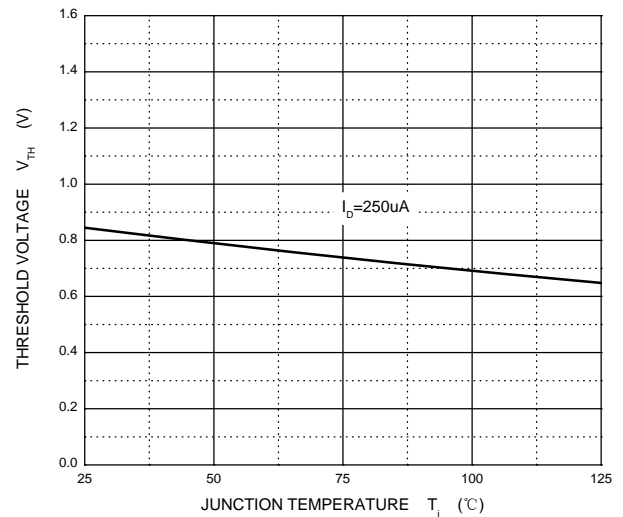

## SOT-323 Package Outline Dimensions

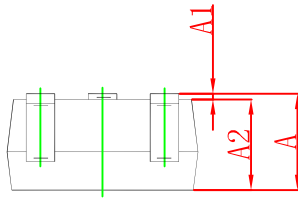
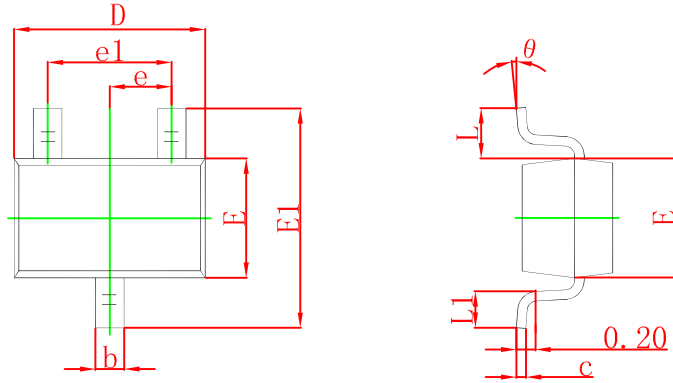

Symbol	Dimensions In Millimeters		Dimensions In Inches	
	Min	Max	Min	Max
A	0.900	1.100	0.035	0.043
A1	0.000	0.100	0.000	0.004
A2	0.900	1.000	0.035	0.039
b	0.200	0.400	0.008	0.016
c	0.080	0.150	0.003	0.006
D	2.000	2.200	0.079	0.087
E	1.150	1.350	0.045	0.053
E1	2.150	2.450	0.085	0.096
e	0.650 TYP		0.026 TYP	
e1	1.200	1.400	0.047	0.055
L	0.525 REF		0.021 REF	
L1	0.260	0.460	0.010	0.018
θ	0°	8°	0°	8°

## SOT-323 Suggested Pad Layout

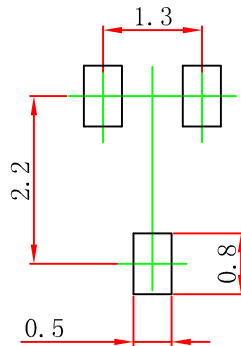

**Note:**

1. Controlling dimension: in millimeters.
2. General tolerance:  $\pm 0.05\text{mm}$ .
3. The pad layout is for reference purposes only.

**NOTICE**

JSCJ reserves the right to make modifications, enhancements, improvements, corrections or other changes without further notice to any product herein. JSCJ does not assume any liability arising out of the application or use of any product described herein.

# SOT-323 Tape and Reel

## SOT-323 Embossed Carrier Tape

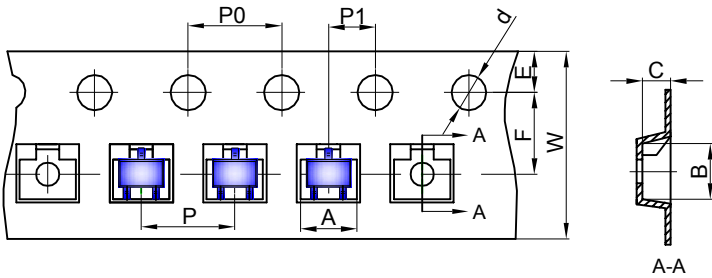

**Packaging Description:**  
 SOT-323 parts are shipped in tape. The carrier tape is made from a dissipative (carbon filled) polycarbonate resin. The cover tape is a multilayer film (Heat Activated Adhesive in nature) primarily composed of polyester film, adhesive layer, sealant, and anti-static sprayed agent. These reeled parts in standard option are shipped with 3,000 units per 7" or 17.8cm diameter reel. The reels are clear in color and is made of polystyrene plastic (anti-static coated).

Dimensions are in millimeter										
Pkg type	A	B	C	d	E	F	P0	P	P1	W
SOT-323	2.25	2.55	1.19	Ø1.55	1.75	3.50	4.00	4.00	2.00	8.00

## SOT-323 Tape Leader and Trailer

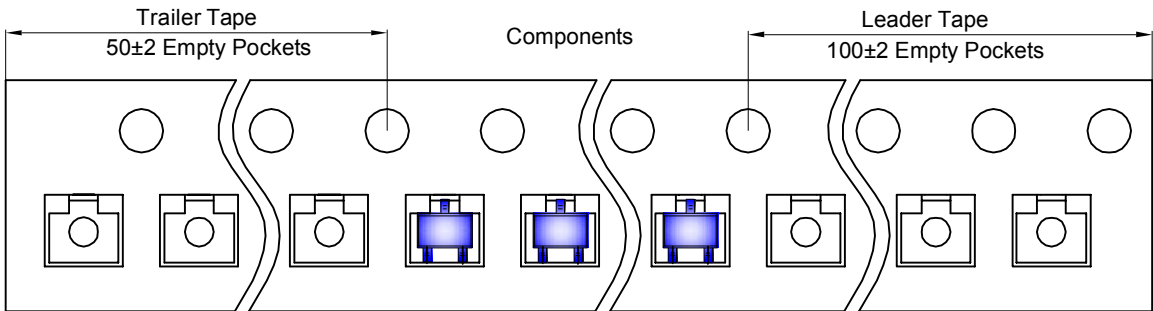

## SOT-323 Reel

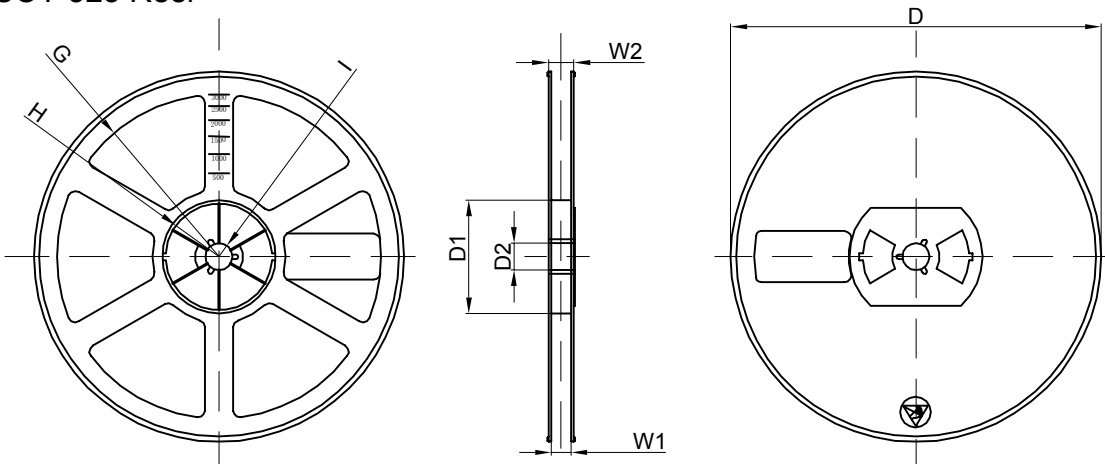

Dimensions are in millimeter								
Reel Option	D	D1	D2	G	H	I	W1	W2
7" Dia	Ø178.00	54.40	13.00	R78.00	R25.60	R6.50	9.50	12.30

REEL	Reel Size	Box	Box Size(mm)	Carton	Carton Size(mm)	G.W.(kg)
3000 pcs	7 inch	30,000 pcs	203×203×195	120,000 pcs	438×438×220	